

Occhioni sfilabili
Removable drawbar eyes
Zugösen mit Schraubende
Anneaux a escrou
Съемные серьги

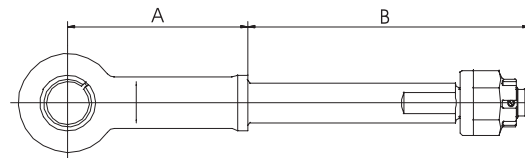

CUNA 438/55

Codice Article number Artikelnummer Code article Код	A mm	B mm	C mm	Peso rimorchiabile Total trailer weight Anhängelast Capacité de traction Буксирный вес t	Peso Weight Gewicht Poids Вес kg	Omologazione Homologation Genehmigung Homologation Сертификация
OC50R01	205	310	35/42	26 ÷ 42	9	46806 R5
OC50R02	217	310	49	26 ÷ 42	11,5	48251 R5
OC50R03	210	328	47	26 ÷ 42	10,9	48244 R5
OC50R04	212	315	47	26 ÷ 42	10	48250 R5
OC50R05	210	328	47	26 ÷ 42	11,2	48249 R5

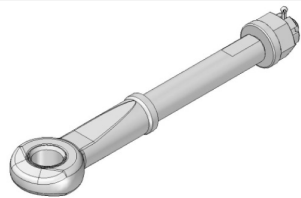
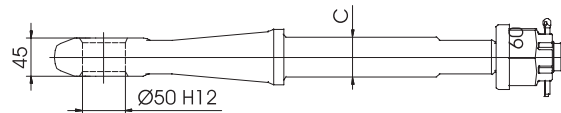

Occhioni sfilabili
Removable drawbar eyes
Zugösen mit Schraubende
Anneaux a escrou
Съемные серьги

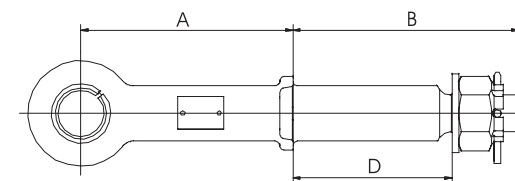
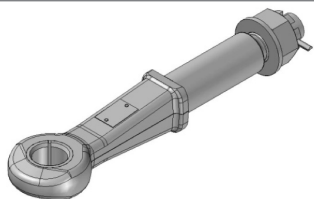

94/20/CE - DIN 74053-1 - ECE R55-01

Codice Article number Artikelnummer Code article Код	A mm	B mm	C mm	D mm	Valore D D-Value D-Wert Valeur D Величина D kN	Peso Weight Gewicht Poids Вес kg	Omologazione Homologation Genehmigung Homologation Сертификация
OC50R09	217	345	49	245	250	12	e3 00-0516
OC50R10	230	245	60	173	250	12,5	E24 010018

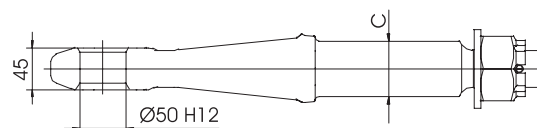

Occhioni flangiati
Flanged drawbar eyes
Flanschzugösen
Anneaux brides
Фланцевые серьги

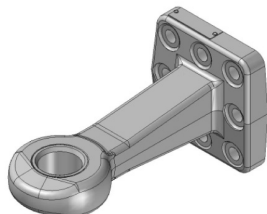

94/20/CE - DIN 74053-1 - ABG

Codice Article number Artikelnummer Code article Код	Valore-Value-Went-Valeur-Величина				Peso rimorchiabile Total trailer weight Anhängelast Capacité de traction Буксирный вес t	Peso Weight Gewicht Poids Вес kg	Omologazione Homologation Genehmigung Homologation Сертификация
	D kN	Dc kN	S kg	V kN			
OC50F60	120	-	1000	-	12	11,6	ABG M 2972
OC51F8E	200	140	1000 2500	75 50	-	11,2	e11 00-1153

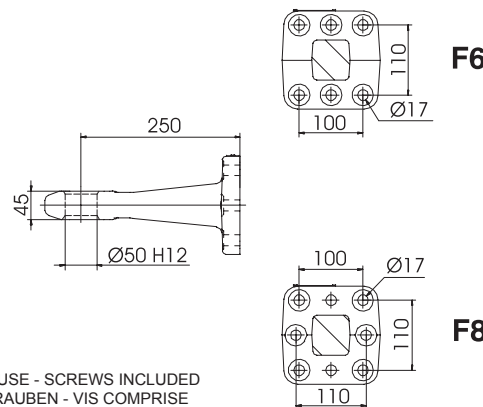

VITI INCLUDE - SCREWS INCLUDED
MIT SCHRAUBEN - VIS COMPRISE
ВИНТЫ ВКЛЮЧЕНЫ

Occhioni flangiati
Flanged drawbar eyes
Flanschzugösen
Anneaux brides
Фланцевые серьги

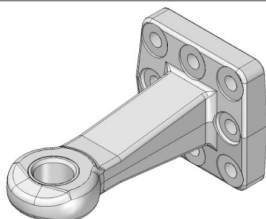

“Heavy duty”

94/20/CE • DIN 74053-1

Codice Article number Artikelnummer Code article Код	Valore-Value-Went-Valeur-Величина				Peso Weight Gewicht Poids Вес kg	Omologazione Homologation Genehmigung Homologation Сертификация
	D kN	Dc kN	S kg	V kN		
OC52F8E	200	135	1000	90	17	e4 00-2089

